

The logo for PAJUNK, featuring the brand name in white, bold, sans-serif capital letters on a teal rectangular background.

**PAJUNK®**

## *EpiLong Kits*

*Systems for epidural anaesthesia*

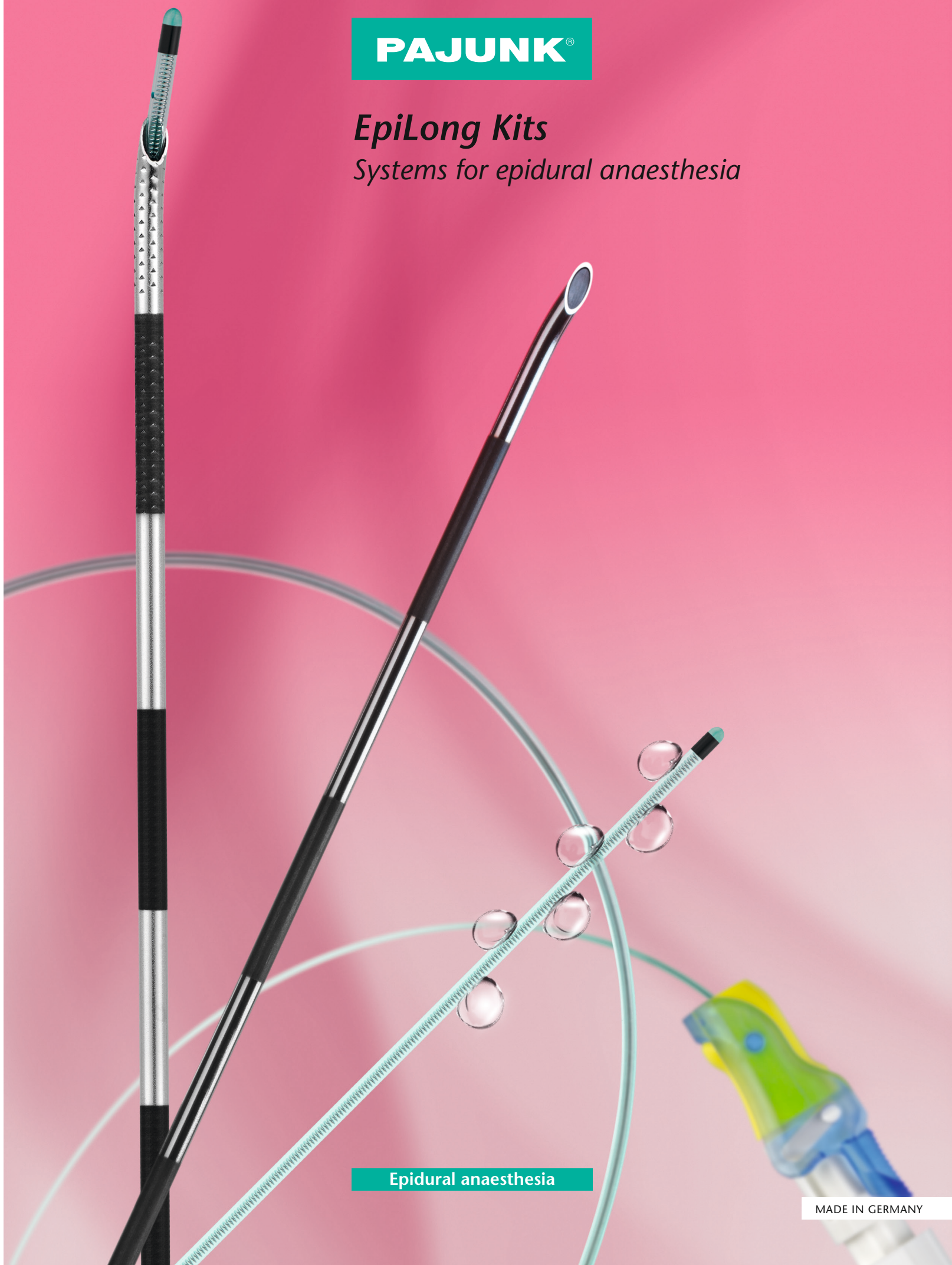

**Epidural anaesthesia**

MADE IN GERMANY

*Atraumatic and gentle*  
**PAJUNK® kits for continuous  
epidural anaesthesia**

*Epidural anaesthesia has served as a proven anaesthetic method for many years. PAJUNK® supports this modern form of puncture technology close to the spinal cord with four different kits for continuous epidural anaesthesia. These kits are available with either the echogenic Tuohy cannula with Cornerstone Reflectors or the EpiLong Soft with rounded catheter design.*

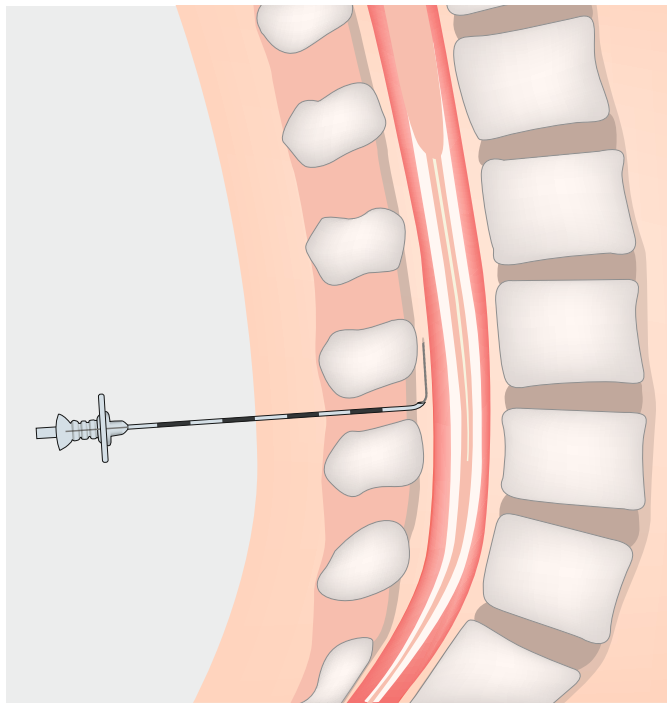

Thanks to the curved Tuohy tip, the catheter automatically bends when the catheter egresses, placing it in the correct position.

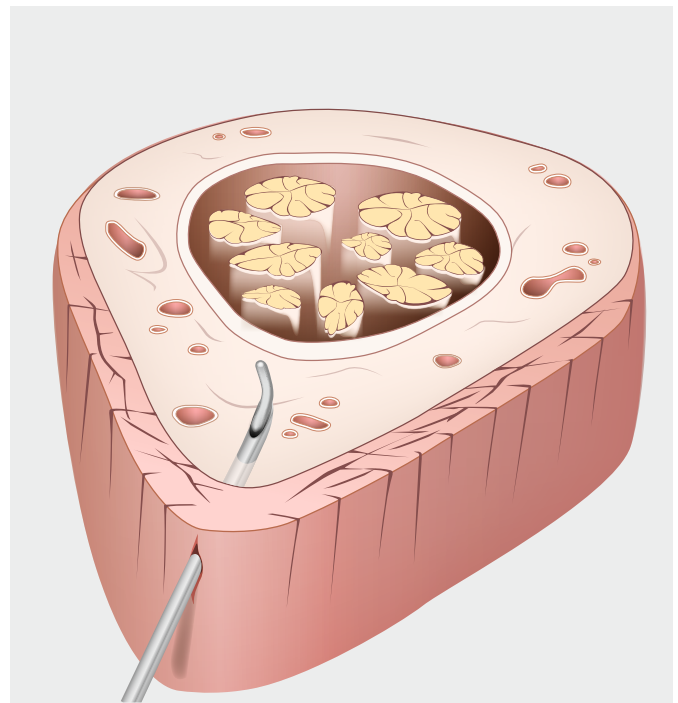

Stainless steel helical coil and soft catheter material combine maximum flexibility and stability in the EpiLong Soft catheter – kinking of the catheter can be ruled out. Six lateral openings enable completely uniform distribution of the anaesthetic.

## The kit variants

PAJUNK® always differentiates amongst four epidural kits, according to the designs of the Tuohy cannula and the epidural catheters:

### EpiLong I

Tuohy cannula with metal stylet + EpiLong catheter with closed tip and three lateral openings

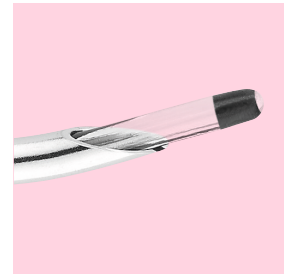
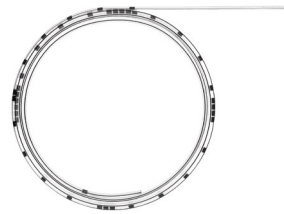
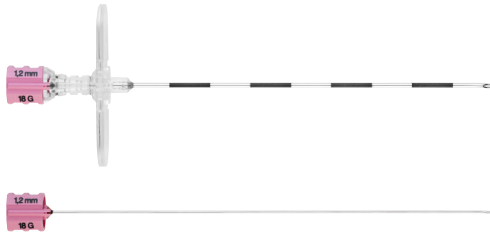

### EpiLong Tuohy

Tuohy cannula with plastic stylet + EpiLong catheter optionally with closed tip and three lateral openings or with a central opening

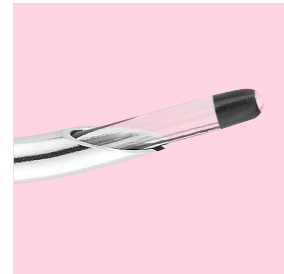
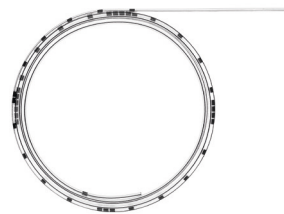
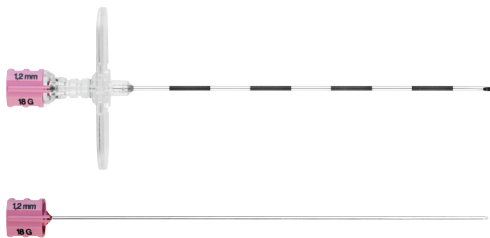

### EpiLong Soft

Tuohy cannula with metal stylet + EpiLong Soft catheter with stainless steel helical coil, closed tip and six lateral openings

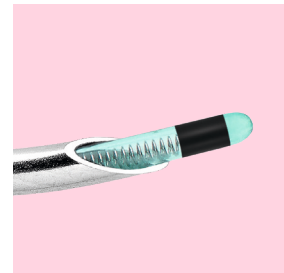
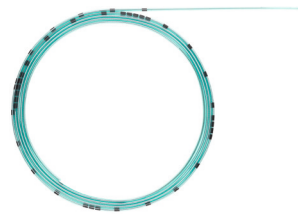
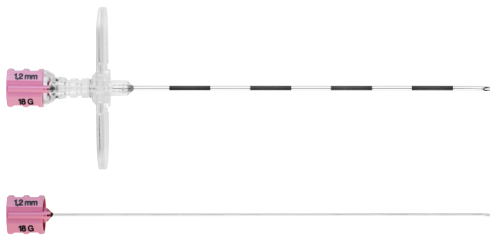

### EpiLong Soft Sono

TuohySono cannula with metal stylet and **Cornerstone Reflectors** + EpiLong Soft catheter with stainless steel helical coil, closed tip and six lateral openings

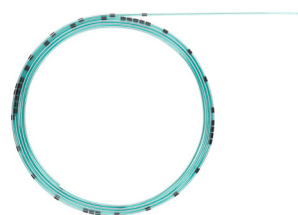
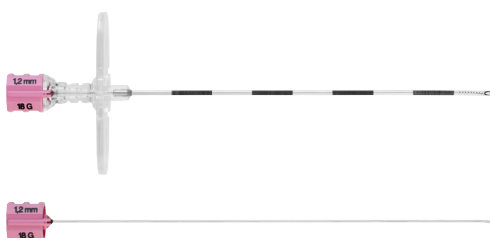

## EpiLong Soft in focus

# EpiLong Soft – combines stability and flexibility in one catheter

The EpiLong Soft catheter developed by PAJUNK® is soft and stable at the same time, offering optimum conditions for precise placement. Six openings on the distal catheter end facilitate perfectly uniform distribution of the anaesthetic. Furthermore, it convinces through its sophisticated details:

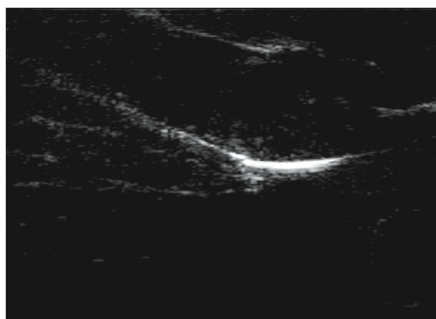
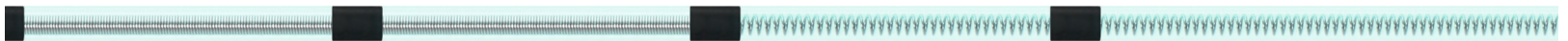

### Graduation for pinpoint placement

The EpiLong Soft catheter has a length graduation on the first 30 cm.

➔ That facilitates pinpoint placement while also serving as a position check.

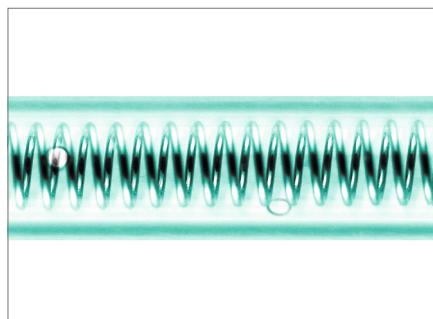

### Soft material – stabilised spiral

The combination of the continually soft catheter material and the interior stainless steel helical coil facilitates optimal handling.

➔ The stability of the stainless steel helical coil permits effortless catheter insertion and advancement. The very soft catheter material also enables greater flexibility when placing the catheter at a 90° angle.

➔ *Memory effect precluded*

➔ *Conjunct softness and stability*

➔ *Unobstructed flow thanks to stainless steel helical coil*

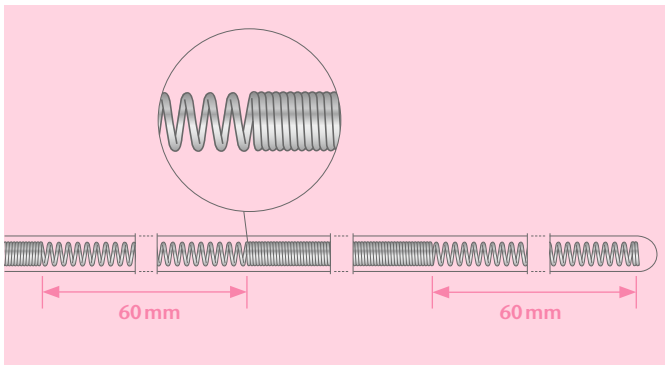

The catheter has three viewing windows each with a length of 60 mm beginning at the catheter tip. The winding of the stainless steel helical coil is more open in these zones. For incorrect positioning, the entry of blood is detected immediately here and it can be responded to accordingly.

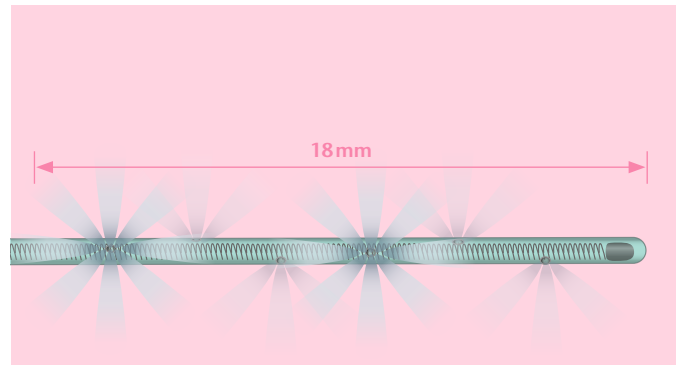

The six lateral openings on the first 18 mm of the catheter, combined with the integrated stainless steel helical coil, ensure completely uniform distribution and effect of the anaesthetic.

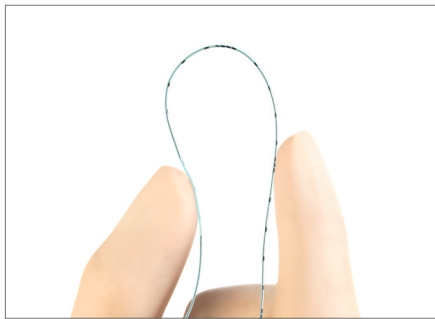
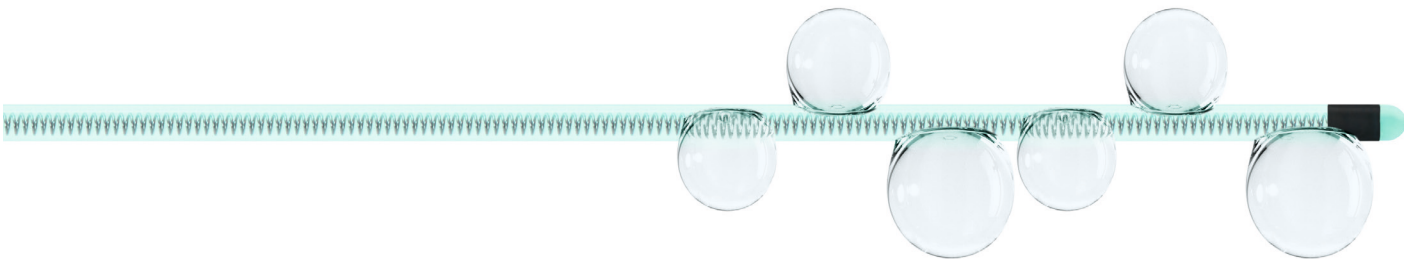

### Unhindered flow of the anaesthetic

Its integrated stainless steel helical coil lends this catheter, with its especially large internal lumen, a maximum of movement while providing kinking resistancy at the same time.

➔ The EpiLong Soft catheter offers a great flow of the anaesthetic and a stable connection to the injection pump.

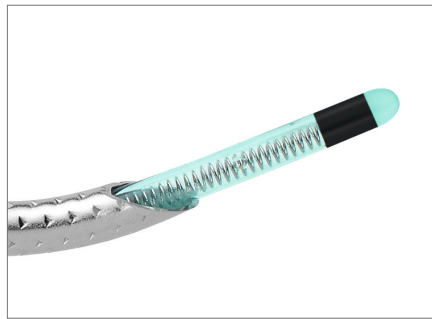

### The rounded tip prevents accidental puncture

The catheter has a closed, very soft tip.  
➔ This minimises the risk of accidental injury to the blood vessels and dura.

➔ *Six lateral openings on the catheter tip*

➔ *Very soft, closed tip*

➔ *Available in the EpiLong Soft kit and EpiLong Soft Sono kit*

TuohySono

## Sono cannulas with maximum echogenicity

The visibility of the cannula in ultrasound guided puncture is very important in preventing damage to neurons and blood vessels.<sup>1</sup> Since even many supposedly echogenic cannulas are sometimes undetectable at angles above 45°<sup>2</sup>, this property has become a key decision-making criterion in the selection of cannulas in practice.<sup>3</sup> The patented Cornerstone Technology developed by PAJUNK® together with Dr. Chris Mitchell was designed specifically to solve this problem, and produces excellent visibility irrespective of the insertion angle.<sup>4</sup> Sono cannulas have a high degree of precision even at steep insertion angles.<sup>5</sup> In this way, Sono cannulas make an important contribution to the safety of the application.<sup>6</sup>

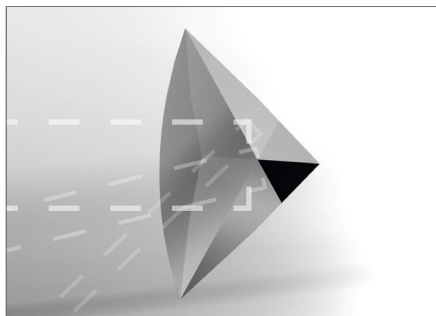
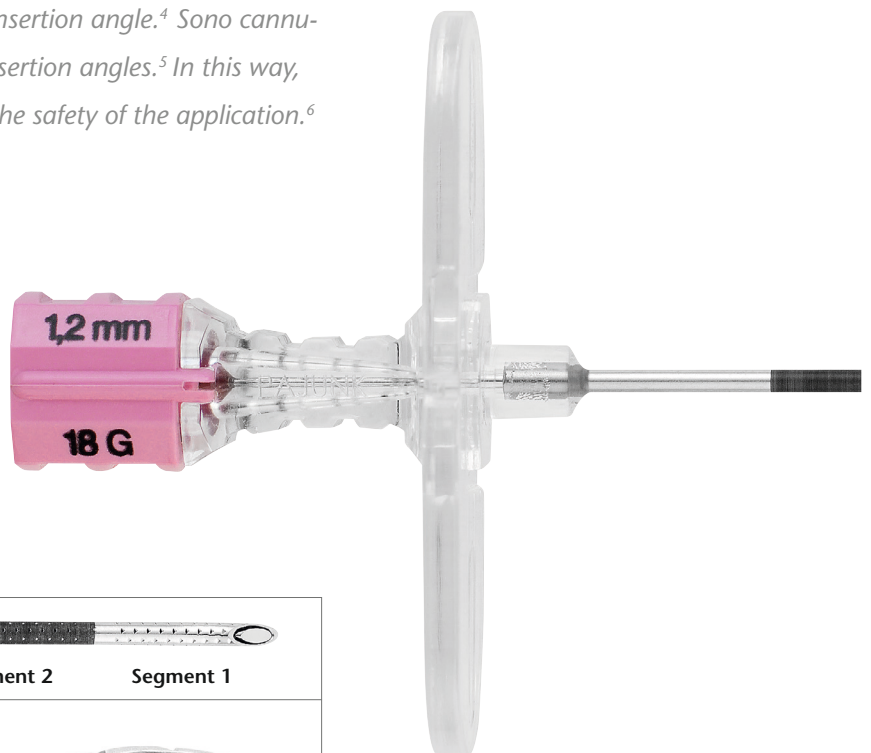

### Echogenic Cornerstone Geometry

The embossed structures in the Cornerstone Reflectors form three surfaces which meet each other at a 90° angle.

➔ This guarantees direct or indirect reflection of the ultrasound waves even at very steep insertion angles.

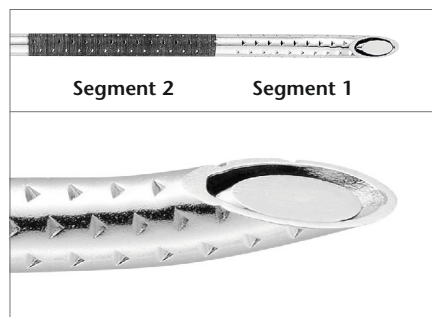

### Visibility up to the tip

The Cornerstone Reflectors are embossed on two 1-cm segments and extend to the tip of the cannula.

➔ This ensures an optimum visibility of the cannula tip.

1 Wiesmann et al., Compound imaging technology and echogenic needle ..., 2013; 38(5): 452-455

2 Uppal, Sondekoppam, Ganapathy, Effect of beam steering on ..., 2014; 61(10): 909-915

3 Sviggum et al., Needle echogenicity in sonographically ..., 2013; 32(1): 143-148

4 Hebard, Hocking, Echogenic technology can improve needle visibility ..., 2011; 36(2): 185-189

5 Edgcombe, Hocking, Sonographic identification of needle tip ..., 2010; 35(2): 207-211

6 Hocking, Mitchell, Optimizing the safety and practice ..., 2012, 604

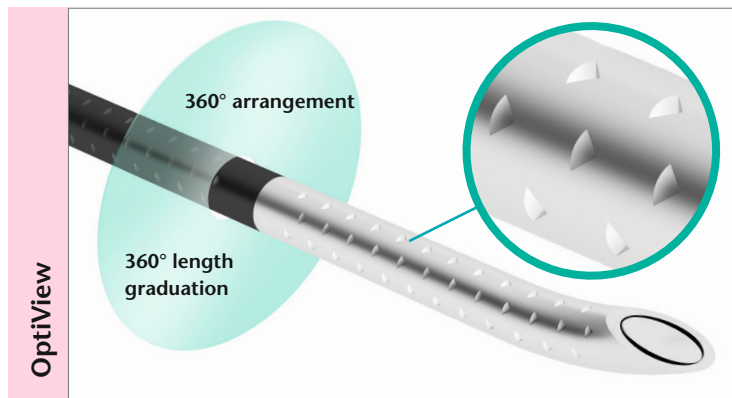

- ➔ Echogenic, three-dimensional Cornerstone Geometry
- ➔ 360° configuration, arranged evenly around the cannula shaft
- ➔ Aligned to the cannula diameter
- ➔ Two marked segments of 1 cm length for positioning
- ➔ Cornerstone Reflectors are embossed as far as the tip of the cannula

= Optimum cannula visibility from the shaft to the tip, irrespective of the insertion angle

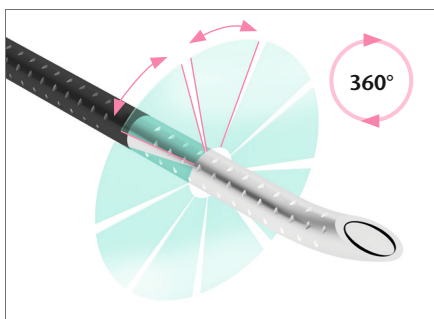
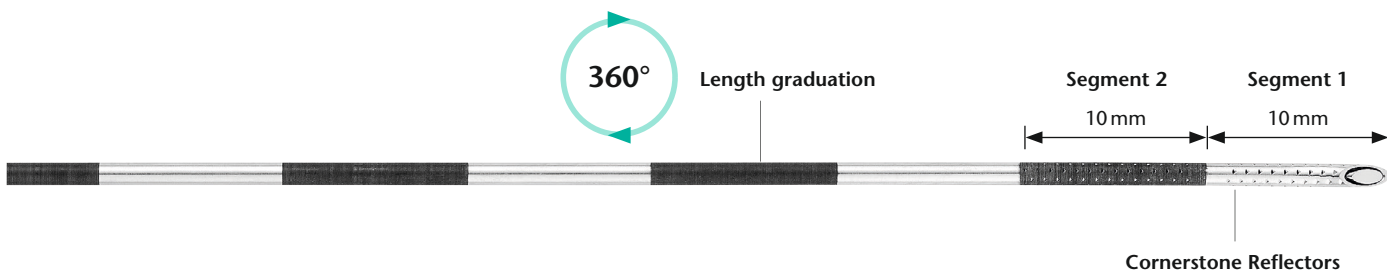

### Sophisticated 360° arrangement

Both cannula segments are graduated all-around with evenly offset Cornerstone Reflectors. The number and layout of these reflectors is matched precisely to the relevant cannula diameter.

➔ Perfect cannula identification is guaranteed in every position.

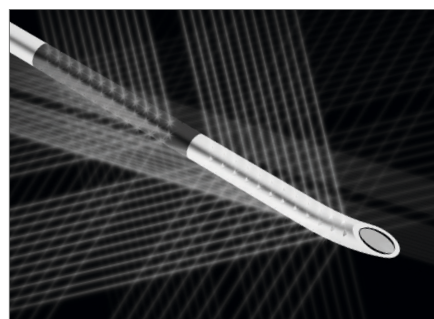

### Visibility irrespective of the insertion angle

The Cornerstone Reflectors are designed that the ultrasound waves are very well reflected even with an insertion angle of 60° to 70°.<sup>2</sup>

➔ Ultrasound waves are reflected along a total length of 20 mm. Cannula shaft and cannula tip can be clearly identified.

➔ Special configuration of the Cornerstone Reflectors for optimum 360° sonographic visibility

➔ Ultrasound waves are reflected along a length of 20 mm

➔ Clear identification of cannula shaft and tip

➔ Reflexion especially at steep insertion angles

➔ 360° length graduation for optimum positioning

➔ Accurately fitting metal stylet

➔ The TuohySono cannula is included in all EpiLong Soft Sono kits

## Innovative catheter fixation

# FixoLong Mini and FixoCath – for more freedom of movement

PAJUNK® developed two different solutions for catheter fixation on patients: FixoLong Mini and FixoCath for catheter sizes 19 G and 20 G. In the context of continuous application in particular, they prevent the catheter being accidentally dislodged if the patient moves, or any interference with the supply of anaesthetic caused by poor patient position.

### FixoLong Mini

With FixoLong Mini, the catheter and MiniFilter are fixed close to the catheter exit, enabling greater freedom of movement in all continuous applications.



### FixoCath

FixoCath is simultaneously a surgical dressing and fixation and is placed directly on the exit point. This also ensures significant freedom of movement for the patient.



### MiniFilter 0.2µm

The 0.2µm flat filter prevents the passage of bacteria.



### ClampingAdapter

The PAJUNK® ClampingAdapter is a special anchoring device which prevents span and ensures optimum anaesthetic flow.

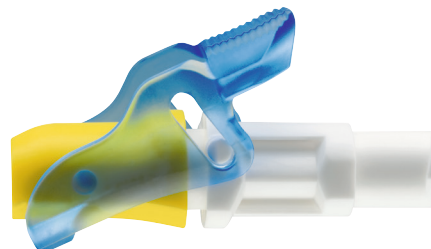



## The kits

# Selection for epidural anaesthesia

### EpiLong I

In the EpiLong I kit, the Tuohy cannula comes standard with a metal stylet. The EpiLong catheter is available solely with closed tip and three lateral openings.

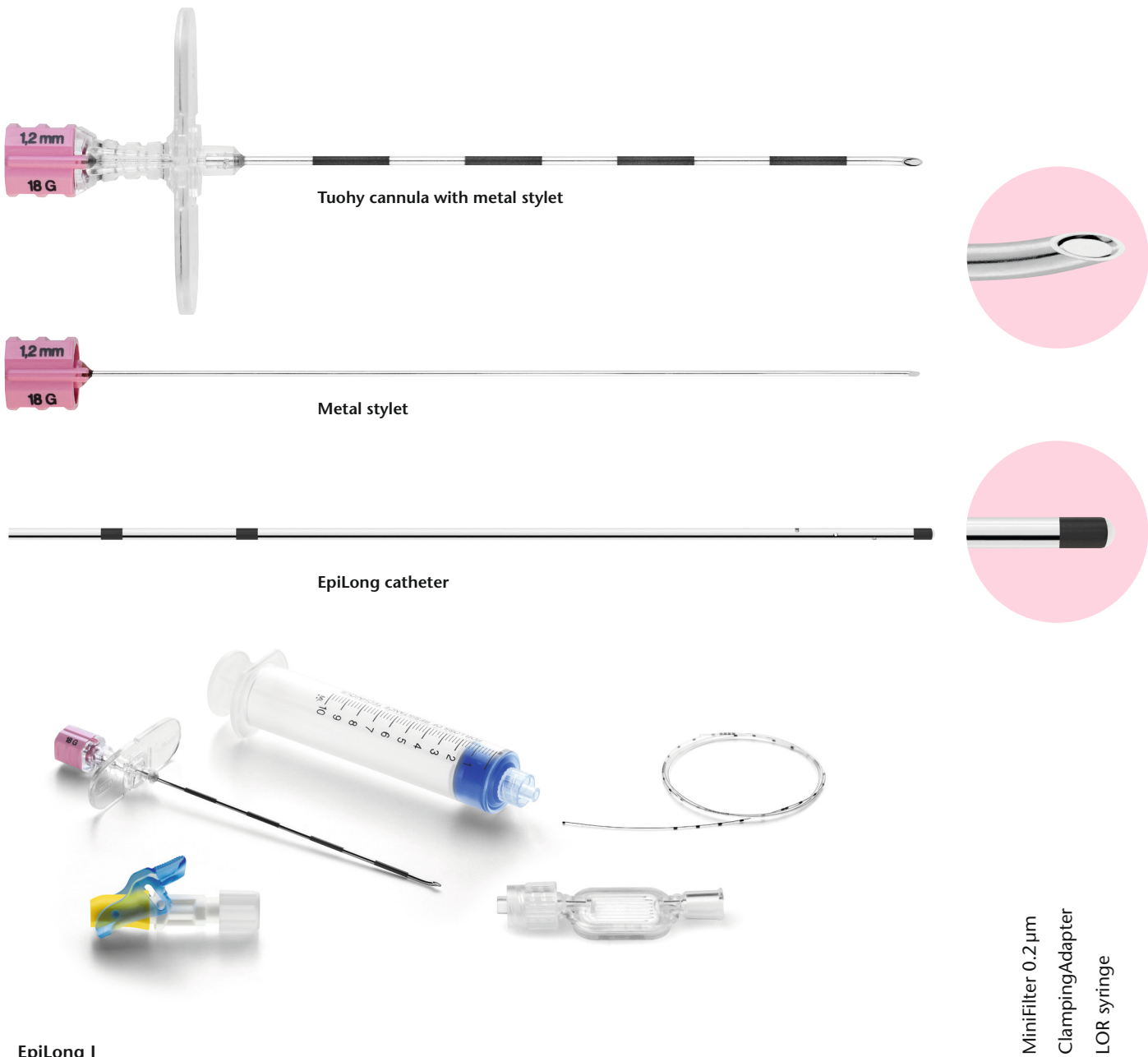

### EpiLong I

Product	Size	Catheter	Item no.	PU	Mini Filter 0.2 µm	Clamping Adapter	LOR syringe
Tuohy cannula	17 G x 80 mm	19 G x 90 cm closed tip with three lateral openings	0431156-48	10	•	•	•
Tuohy cannula	17 G x 90 mm	19 G x 90 cm closed tip with three lateral openings	0431155-48	10	•	•	•
Tuohy cannula	18 G x 90 mm	20 G x 90 cm closed tip with three lateral openings	0431155-51	10	•	•	•
Tuohy cannula	19 G x 45 mm	23 G x 50 cm closed tip with three lateral openings	0131153-50	10	•	•	•

## EpiLong Tuohy

The Tuohy cannula in this kit is equipped with a plastic stylet, making it correspondingly less expensive. The standard epidural catheter is optionally available with closed tip and three lateral openings or with a central opening.

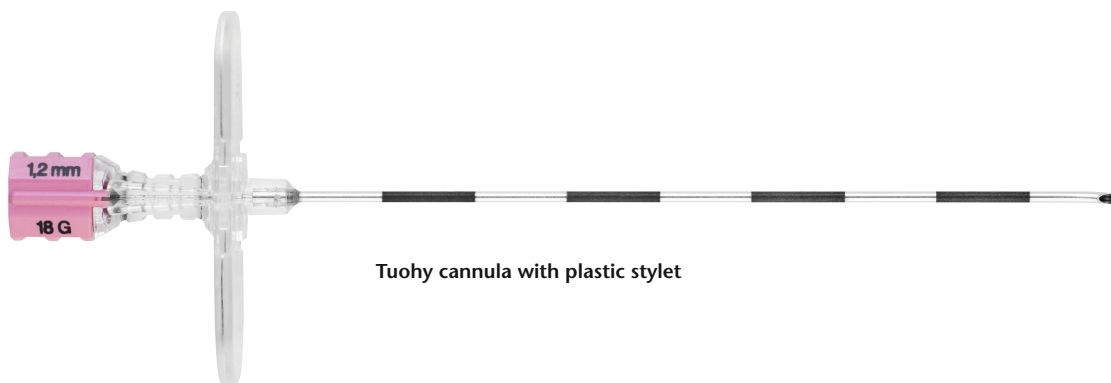

Tuohy cannula with plastic stylet

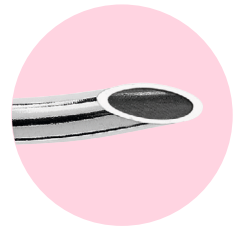

Plastic stylet



EpiLong catheter with closed tip and three lateral openings

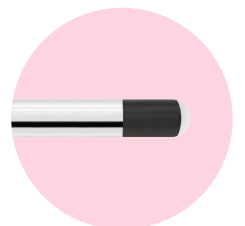

EpiLong catheter with central opening

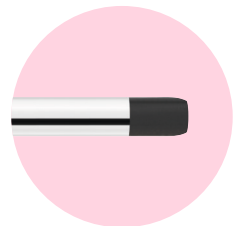



FixoLong Mini



FixoCath

EpiLong Tuohy

FixoLong Mini  
 FixoCath  
 MiniFilter 0.2 µm  
 ClampingAdapter  
 LOR syringe Lock  
 LOR syringe Slip

Product	Size	Catheter	Item no.	PU	FixoLong Mini	FixoCath	MiniFilter 0.2 µm	ClampingAdapter	LOR syringe Lock	LOR syringe Slip
Tuohy cannula	18 G x 90 mm	20 G x 90cm central opening	0521152-51	10			•	•		
Tuohy cannula	18 G x 80 mm	20 G x 90cm closed tip with three lateral openings	0331153-51	10			•	•	•	
Tuohy cannula	18 G x 80 mm	20 G x 90cm closed tip with three lateral openings	0531153-51	10	•		•	•		•
Tuohy cannula	18 G x 90 mm	20 G x 90cm closed tip with three lateral openings	0331152-51	10			•	•	•	
Tuohy cannula	18 G x 90 mm	20 G x 90cm closed tip with three lateral openings	0331252-51	10		•	•	•	•	
Tuohy cannula	18 G x 90 mm	20 G x 90cm closed tip with three lateral openings	0321152-51	10			•	•		
Tuohy cannula	18 G x 90 mm	20 G x 90cm closed tip with three lateral openings	0311152-51	10				•		
Tuohy cannula	18 G x 90 mm	20 G x 90cm closed tip with three lateral openings	0531152-51	10	•		•	•		•
Tuohy cannula	17 G x 80 mm	19 G x 90cm closed tip with three lateral openings	0331153-48	10			•	•	•	
Tuohy cannula	16 G x 90 mm	19 G x 90cm closed tip with three lateral openings	0331152-49	10			•	•	•	
Tuohy cannula	16 G x 90 mm	19 G x 90cm closed tip with three lateral openings	0321152-49	10			•	•		

## EpiLong Soft

The EpiLong Soft catheter is, thanks to its integrated stainless steel helical coil, very flexible while kink free at the same time. It has a closed tip and six lateral openings. The Tuohy cannula in this kit comes standard with a metal stylet.

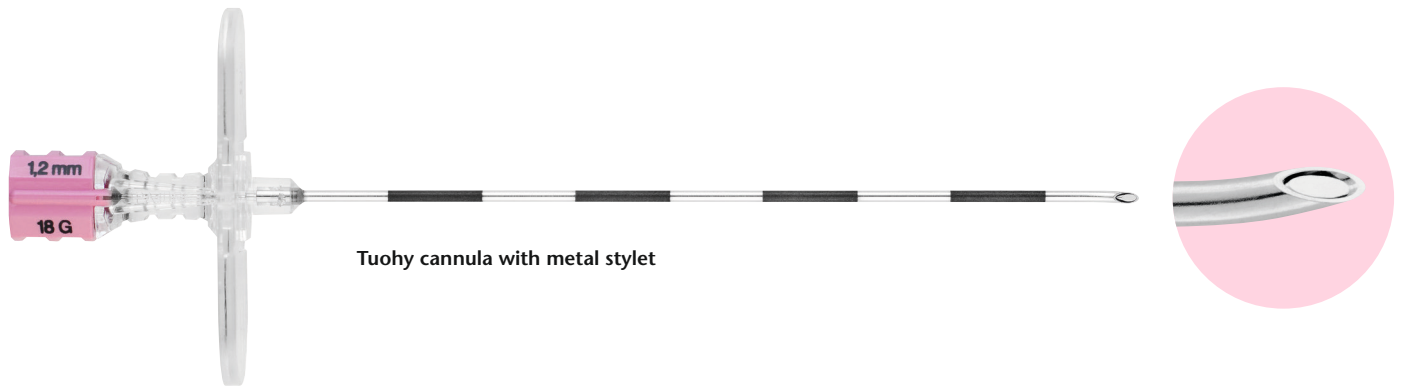

Tuohy cannula with metal stylet

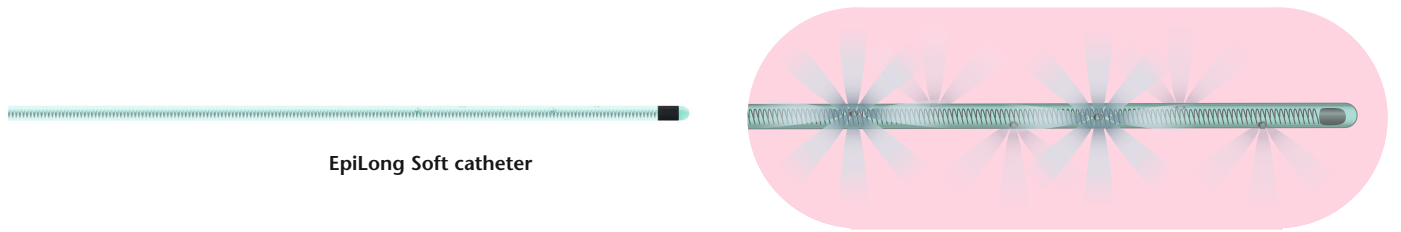

EpiLong Soft catheter

Six lateral openings on the first 18mm of the catheter tip

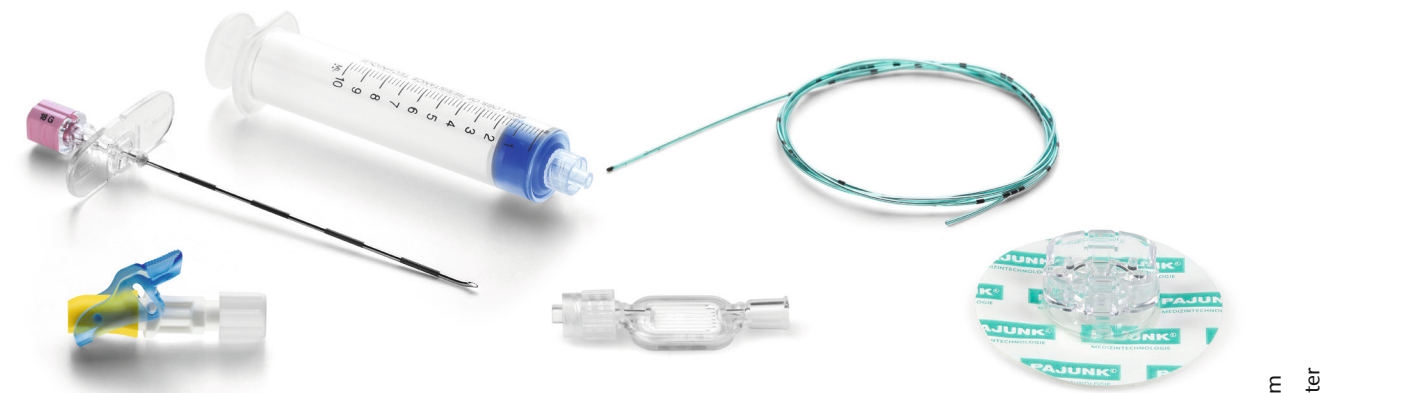

FixoLong Mini  
MiniFilter 0.2µm  
ClampingAdapter  
LOR syringe

### EpiLong Soft

Product	Size	Catheter	Item no.	PU				
Tuohy cannula	18 G x 90 mm	20 G x 90 cm, stainless steel helical coil, closed tip with six lateral openings	0431157-51	10	•	•	•	•
Tuohy cannula	17 G x 90 mm	19 G x 90 cm, stainless steel helical coil, closed tip with six lateral openings	0431157-48	10	•	•	•	•
Tuohy cannula	17 G x 90 mm	19 G x 90 cm, stainless steel helical coil, closed tip with six lateral openings	0421157-48	10	•	•	•	•

## EpiLong Soft Sono

This kit includes the EpiLong Soft catheter with integrated stainless steel helical coil, closed tip and six lateral openings. In addition, the design of the TuohySono cannula with Cornerstone Reflectors ensures optimum visibility under ultrasound.

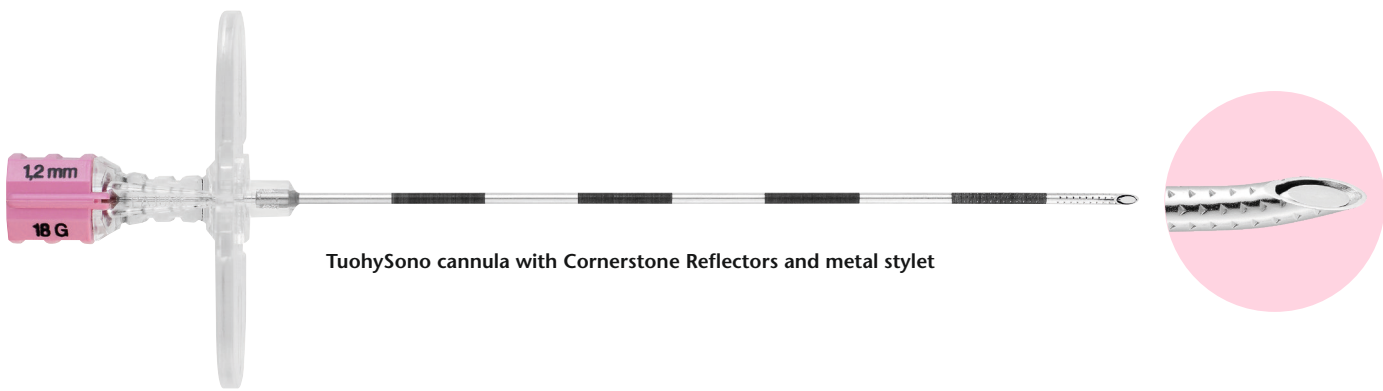

TuohySono cannula with Cornerstone Reflectors and metal stylet

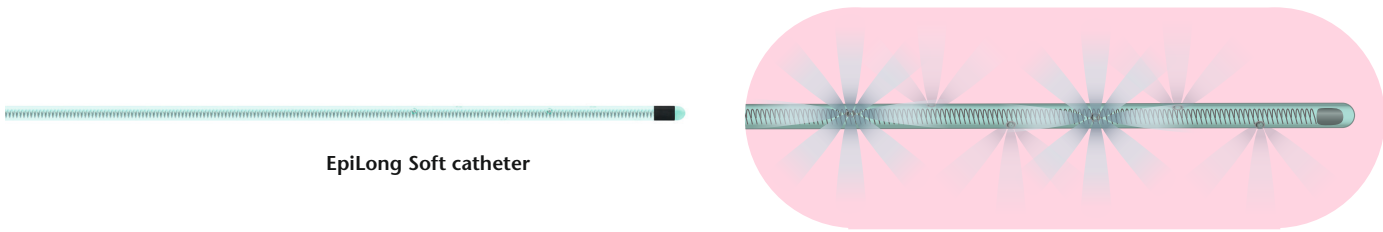

EpiLong Soft catheter

Six lateral openings on the first 18mm of the catheter tip

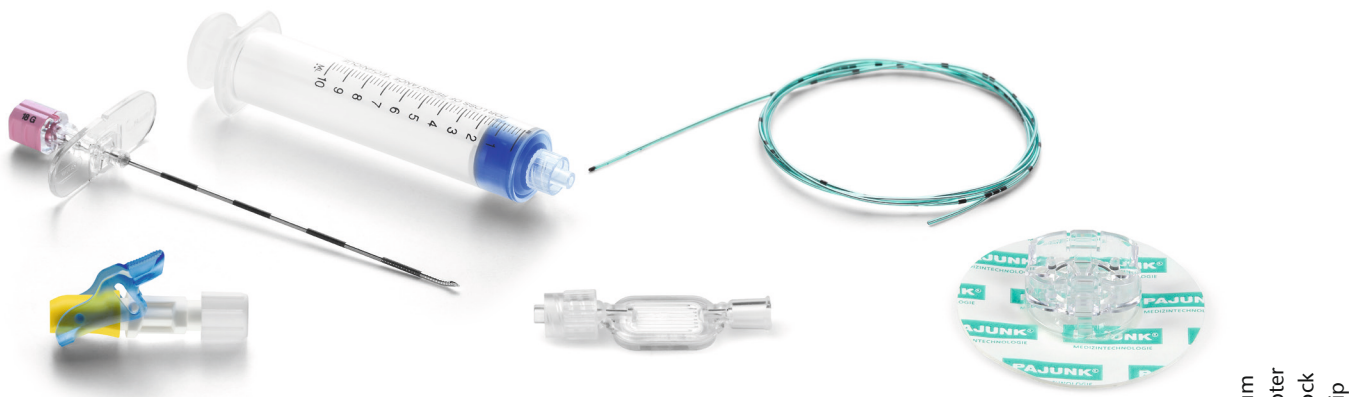

FixoLong Mini  
MiniFilter 0.2µm  
ClampingAdapter  
LOR syringe Lock  
LOR syringe Slip

### EpiLong Soft Sono

Product	Size	Catheter	Item no.	PU					
TuohySono cannula	18 G x 50 mm	20 G x 90 cm, stainless steel helical coil, closed tip with six lateral openings	0631187-51	10	•	•	•	•	•
TuohySono cannula	18 G x 90 mm	20 G x 90 cm, stainless steel helical coil, closed tip with six lateral openings	0431187-51	10	•	•	•	•	•
TuohySono cannula	17 G x 90 mm	19 G x 90 cm, stainless steel helical coil, closed tip with six lateral openings	0431187-48	10	•	•	•	•	•

# Epidural anaesthesia

## Kit components

### Tuohy cannulas

Product	Size	Item no.	PU
<b>TuohySono</b>			
with metal stylet and wings	17 G x 90 mm	1085-4M090	25
	18 G x 50 mm*	1085-4K050	25
	18 G x 90 mm	1085-4K090	25
	18 G x 120 mm	1085-4K120	10
<b>Tuohy</b>			
with metal stylet and wings	21 G x 90 mm	1150-4F090	25
	19 G x 50 mm	1150-4I050	25
	19 G x 80 mm	1150-4I080	25
	19 G x 90 mm	1150-4I090	25
	18 G x 50 mm*	1150-4K050	25
	18 G x 80 mm	1150-4K080	25
	18 G x 90 mm	1150-4K090	25
	18 G x 120 mm	1150-4K120	10
	18 G x 150 mm	1150-4K150	10
	17 G x 80 mm	1150-4M080	25
	17 G x 90 mm	1150-4M090	25
	17 G x 120 mm	1150-4M120	10
	17 G x 150 mm	1150-4M150	10
	16 G x 80 mm	1150-4O080	25
	16 G x 90 mm	1150-4O090	25
	16 G x 120 mm	1150-4O120	10
<b>Tuohy</b>			
with plastic stylet and wings	19 G x 90 mm	1150-6I091	25
	18 G x 80 mm	1150-6K081	25
	18 G x 90 mm	1150-6K091	25
	17 G x 80 mm	1150-6M081	25
	17 G x 90 mm	1150-6M091	25
	16 G x 90 mm	1150-6O091	25

\* with 0.5 cm graduation



TuohySono cannula with metal stylet



Tuohy cannula with metal stylet

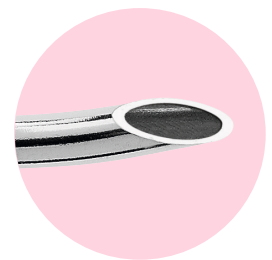

Tuohy cannula with plastic stylet

### Crawford cannulas

Product	Size	Item no.	PU
<b>CauDal</b>			
with 45° grinding, wings and graduated depth stop	23 G x 25 mm	1149-12D025	25
	22 G x 40 mm	1149-12E040	25

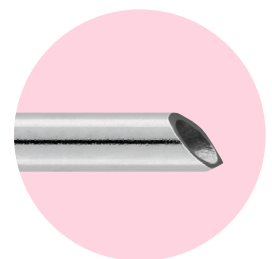

Crawford cannula

## Catheter

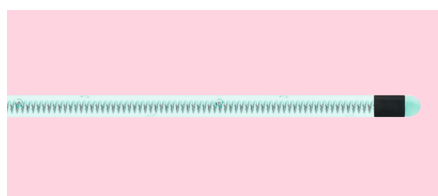

EpiLong Soft catheter with closed tip and six lateral openings



EpiLong catheter with closed tip and three lateral openings

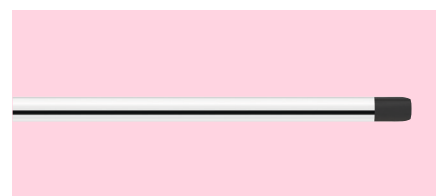

EpiLong catheter with open tip

Product	Size	Closed	Open	Steel mandrin	Stainless steel helical coil	Adapter	Item no.	PU
EpiLong Soft Cath	20 G x 90 cm	•			•	•	041151-37R	10
EpiLong Soft Cath	19 G x 90 cm	•			•	•	041151-37P	10
EpiLong Cath	20 G x 90 cm	•		•		•	001151-37C	10
EpiLong Cath	20 G x 90 cm		•	•		•	011151-37C	10
EpiLong Cath	20 G x 90 cm	•				•	021151-37C	10
EpiLong Cath	19 G x 90 cm	•		•		•	001151-37A	10
EpiLong Cath	19 G x 90 cm	•				•	021151-37A	10
EpiLong Cath	19 G x 90 cm		•			•	031151-37A	10

## Kit components



FixoLong Mini



MiniFilter 0.2µm



FixoLong Mini with MiniFilter 0.2µm



FixoCath

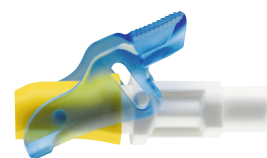

ClampingAdapter

Product	Item no.	PU
FixoLong Mini	001151-43	10
FixoLong Mini with MiniFilter 0.2µm	001151-44	10
MiniFilter 0.2µm	001151-38K	10
FixoCath	001151-37Z	10
ClampingAdapter, yellow	001151-37V	10
LOR 10ml	0001151-45	10



LOR 10ml

## EpiLong Soft kit 17 G (individual kit)



- 1 Tuohy cannula 17 G x 90 mm with wings and metal stylet
- 1 EpiLong Soft catheter 19 G x 90 cm with stainless steel helical coil
- 1 ClampingAdapter (white)
- 1 MiniFilter 0.2µm
- 1 FixoLong Mini
- 1 Injection cannula 16 G x 38 mm
- 1 Injection cannula 18 G x 38 mm
- 1 Injection cannula 22 G x 38 mm
- 1 10ml LOR syringe Luer Lock
- 1 Syringe 10 ml Luer
- 1 Syringe 20 ml Luer
- 1 Syringe 3 ml Luer Lock
- 3 Sponge sticks
- 1 Filter straw 100 mm
- 1 Fenestrated drape
- 5 Compresses
- 1 wrapping cloth 90 x 90 cm

Item no. 0431157-848

## Studies

- **Edgcombe H., Hocking G.** Sonographic identification of needle tip by specialists and novices: a blinded comparison of 5 regional block needles in fresh human cadavers, *Reg. Anesth. Pain Med.* 2010 March–April; 35(2): 207–211
- **Hebard S., Hocking G.** Echogenic technology can improve needle visibility during ultrasound-guided regional anesthesia, *Reg. Anesth. Pain Med.* 2011 March–April; 36(2): 185–189
- **Hocking G. Mitchell C.** Optimizing the safety and practice of ultrasound-guided regional anesthesia: the role of echogenic technology, *Curr. Opin. Anaesthesiol.* 2012 Oct; 25(5): 603–609
- **Sviggum H. P., Ahn K., Dilger J. A., Smith H. M.** Needle echogenicity in sonographically guided regional anesthesia: blinded comparison of 4 enhanced needles and validation of visual criteria for evaluation, *J. Ultrasound Med.* 2013 Jan; 32(1): 143–148
- **Uppal V., Sondekoppam R. V., Ganapathy S.** Effect of beam steering on the visibility of echogenic and non-echogenic needles: a laboratory study, *Can. J. Anesth.* 2014 Oct; 61(10): 909–915
- **Wiesmann T., Borntträger A., Zoremba M., Neff M., Wulf H., Steinfeldt T.** Compound imaging technology and echogenic needle design: effects on needle visibility and tissue imaging, *Reg. Anesth. Pain Med.* 2013 Sep–Oct; 38(5): 452–455

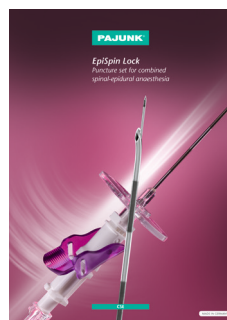

**PAJUNK® GmbH**  
Medizintechnologie  
Karl-Hall-Strasse 1  
D-78187 Geisingen/Germany  
Phone +49 (0) 77 04/92 91-0  
Telefax +49 (0) 77 04/92 91-6 00  
[www.pajunk.com](http://www.pajunk.com)

**PAJUNK® Medical Produkte GmbH**  
D.A.CH • BeNeLux  
Karl-Hall-Strasse 1  
D-78187 Geisingen/Germany  
Phone +49 (0) 77 04/80 08-0  
Telefax +49 (0) 77 04/80 08-150  
[www.pajunk.com](http://www.pajunk.com)